

26TH LIMES CONGRESS

8.-14. September 2024
Batumi, Georgia

CONFERENCE PROGRAMME





Bronze lamp featuring a Nubian head

Bronze lamp found in Apsaras in a mixed layer with stamped CBM marked COHIIISAGI. Likely from the 2nd-3rd century.

Dear Participants,

We are pleased to present you with the programme for the XXVI Limes Congress Batumi 2024. We hope that the information in this booklet will help you navigate Batumi State University and choose the panels and presentations that interest you the most. Inside, you will also find details about other events planned outside the university, including excursions to archaeological sites in Adjara and beyond.

Of course, we understand that this brief collection of useful information may not answer all of your questions. We encourage you to reach out to us and the volunteers, who will be available to assist you throughout the Congress.

We wish you an enjoyable stay in Batumi and Adjara.

Zaur Akhvediani

Deputy Minister of Education, Culture
and Sport of Autonomous Republic of Ajara,
Director of the Cultural Heritage
Protection Agency of Ajara

Radosław Karasiewicz-Szczypiorski
Polish Centre of Mediterranean Archaeology,
University of Warsaw



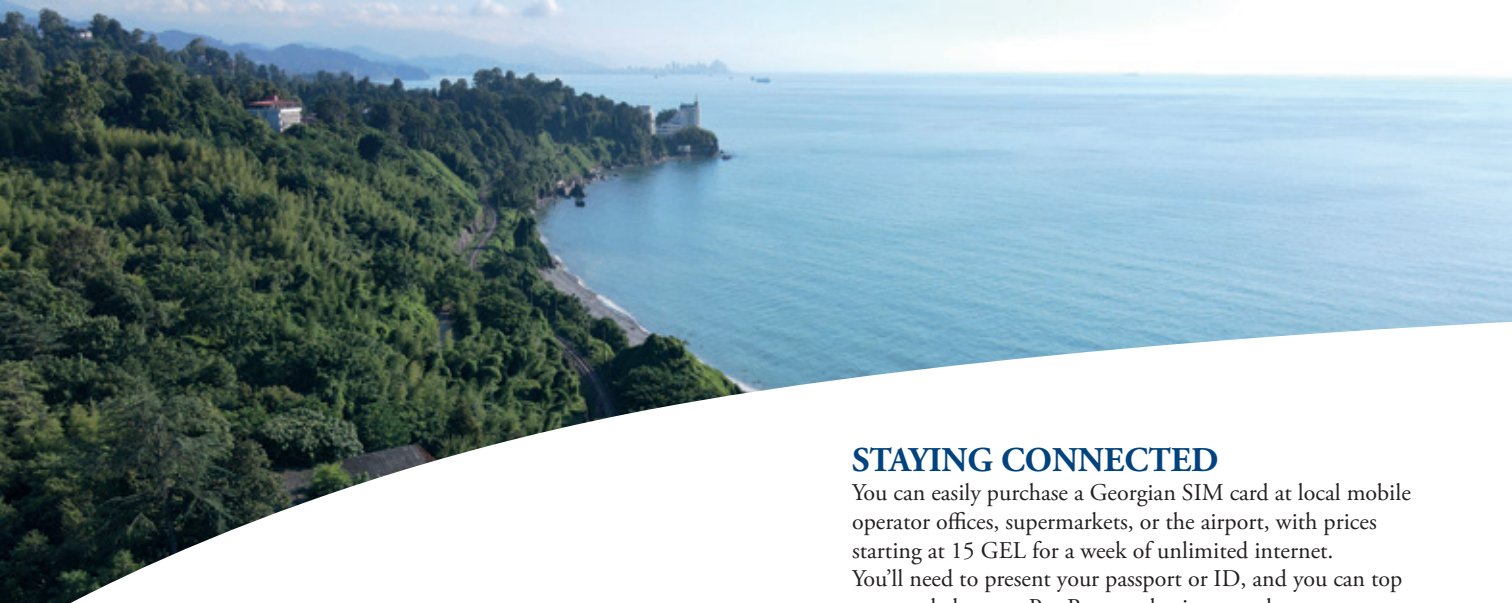

EMERGENCY NUMBERS

+995 557 708 732 – on-call number daily emergencies

+995 558 289 335 – on-call number helpdesk

112 – emergency number for police, fire rescue and medical services

HEALTH INSURANCE

There are few clinics in Adjara that cooperate with foreign insurance companies. Therefore, foreign visitors in most cases will have to pay for services on the site and prepare a document for their insurance agencies.

PUBLIC TRANSPORT

The main types of public transport: buses, minibuses, taxis.

• **Bus:** to use municipal transportation, get a free contactless card from the “Metro Service +” center (55 Gorgasali St., Batumi) or Bank of Georgia’s Express Pay machines. Select “Order the Transport card” and follow the instructions.

The fare with a BATUMI CARD is 0.30 GEL.

• **Minibuses (marshrutkas):** the fare for a ride within city is usually 0.50GEL, payable to the driver when you get off. The fare for a ride outside Batumi ranges from 1 to 8 GEL.

• **Taxi:** some taxis carry meters with fixed rates (1 km is about 0.50-0.60 GEL), but not all. There are also private taxis in the city that don’t use taximeter. Agree the price before you get in.

• **Car rent:** the average rate for a one-day rental starts from 120-150 GEL per day. For more detailed information, please contact Batumi Tourist Information Centers.

STAYING CONNECTED

You can easily purchase a Georgian SIM card at local mobile operator offices, supermarkets, or the airport, with prices starting at 15 GEL for a week of unlimited internet. You’ll need to present your passport or ID, and you can top up your balance at Pay Boxes, selecting your language preference. Free public Wi-Fi is available along Batumi Boulevard, and most cafes, restaurants, and bars offer free Wi-Fi as well. Additionally, there are several internet cafes throughout the city.

ESSENTIAL TRAVEL TIPS

- Get a local SIM card
- Use a taxi app for safer and more reliable rides
- Stay mindful of road safety – traffic can be unpredictable
- Carry some cash, as not all places accept cards
- Familiarize yourself with tipping customs to avoid awkward moments
- Embrace the late start – days in Georgia begin a bit later than you might expect
- Double-check opening hours – Google Maps isn’t always accurate here
- Respect the dress code when visiting religious sites
- Enjoy khinkali the traditional way – skip the knife and fork, use your hands instead

- **Hello:** გამარჯობა (gamarjoba)
- **Please:** გთხოვთ (gtkhovt)
- **Thank you:** გმადლობთ (madloba)
- **You’re welcome:** არაფერის (arapris)
- **Excuse me:** უკაცრავად (ukatsravad)
- **I’m sorry:** ბოდიში (bodishi)

MAIN VENUE

All congress sessions will take place from Monday, September 9th, at **Shota Rustaveli State University** in Batumi.

Address: 32/35 Rustaveli/Ninoshvili st. Batumi, 6010.

BOOKSTANDS

During the congress the following Publishing Houses stands will be available:

- **Archaeopress Publishing Ltds**
- **BAR Publishing**
- **Römisch-Germanische Kommission des Deutschen Archäologischen Instituts**



PLAN OF THE VENUE AT THE UNIVERSITY

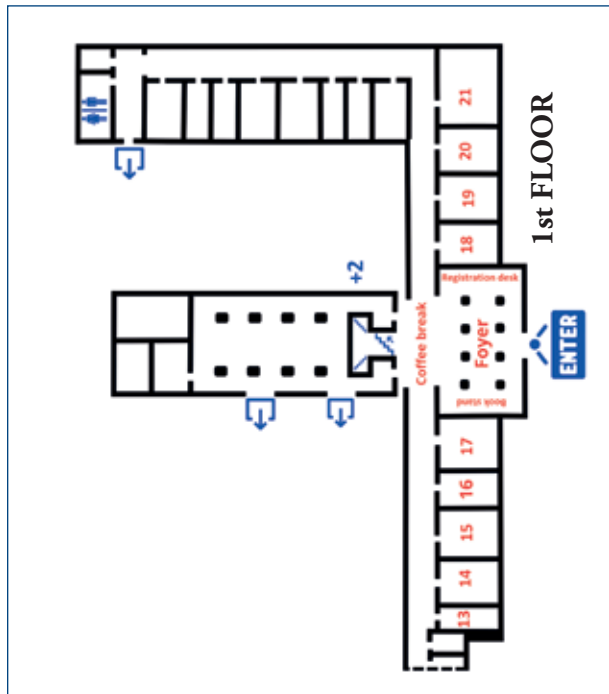
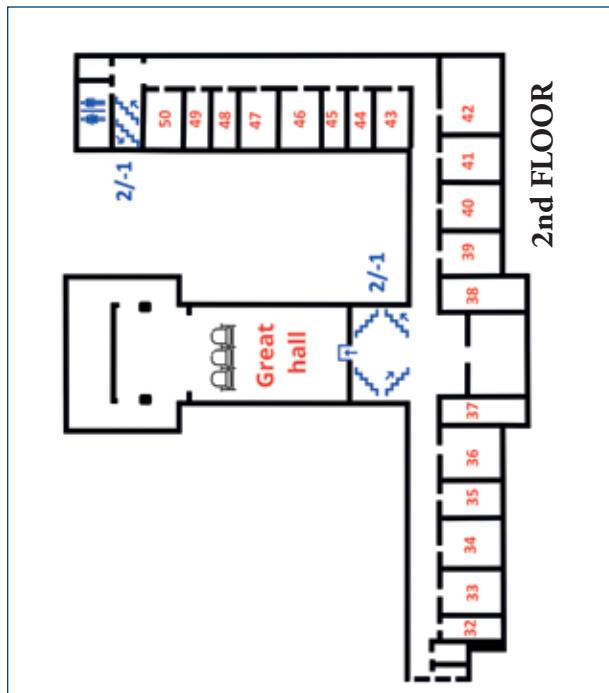

SUNDAY OPENING CEREMONY

The opening ceremony of the XXVI Limes Congress will take place at the **Courtyard by Marriott Batumi Hotel** starting at **16:00**. The registration and welcome reception for attendees will be available from **15:00** at the same hotel.

Address: 5 Sherif Khimshiashvili St, Batumi 6000, Georgia

OPENING CEREMONY SCHEDULE

15:00

Registration

15:30

Welcome drink

16:00

Opening Ceremony of XXVI Limes Congress

Introduction:

Giorgi Batsikadze, Martin Lemke

Speakers:

Zaur Akhvlediani

Deputy Minister of Education, Culture and Sport of Autonomous Republic of Ajara, Director of the Cultural Heritage Protection Agency of Ajara

Radosław Karasiewicz-Szczypiorski

Polish Centre of Mediterranean Archaeology, University of Warsaw

Tornike Rizhvadze

Chairman of the Government of the Autonomous Republic of Adjara

Maia Khajishvili

Minister of Education, Culture and Sport

Magdalena Wojdasiewicz

Director of the Polish Institute Tbilisi, Polish Embassy Georgia

Archil Chikovani

Mayor of Batumi

Tamar Siradze

Vice-rector of Batumi Shota Rustaveli State University

Hight Representative

University of Warsaw

Bartosz Kontny

Dean of Faculty of Archaeology University of Warsaw

Giorgi Tavamaishvili

Archaeologist

Emzar Kakhidze

Batumi Archaeological Museum, Ajara Museums

Rebecca Jones & Andreas Thiel

Chairs of the Congress of Roman Frontier Studies

Christoph Rummel

Representative of Römisch-Germanische Kommission, Germany

Harry van Enckevort

Representative of Limes 25 Nijmegen

Nemanja Mrđić

Representative of Limes 24 Viminacium

Announcements

18:00

Concert at Batumi Summer Theatre

19:30

Dinner at Riviera restaurant

9.09 MONDAY ROOM 43

10:00
SESSION 10

Back to the drawing board – new approaches, concepts and documentation methods for studies on the Roman frontier fortifications.
Session introduction:
Ivan Bogdanović,
Piotr Zakrzewski

10:15
Piotr Zakrzewski:

The fortifications of the Novae Legionary Fortress – a curious lesson on the Roman pragmatism and construction planning

10:30

Bebina Milovanović, Ivana Kosanović, Bojan Popović: Roman fortification Gerulata in Upper Moesia

10:45

Ivan Bogdanović: From the remains of the walls to the defence system of the Viminacium legionary fortress

11:00

Stefan Pop-Lazić: Some aspects of design of Singidunum Legionary fortress

11:15

Tino Leleković: Unlocking the Secrets of Archaeological Sites and Roman Border Organization on the Croatian Section of the Limes:

Harnessing Lidar, Geophysical Surveys, Historical Maps, and Written Sources

11:30
DISCUSSION

11:45
► COFFEE BREAK

12:15

Dávid Bartus: STRATOS – a new software to document (not only) the legionary fortress in Brigetio

12:30

Mario Wallner, Christian Gugl, Klaus Löcker, Eduard Pollhammer, Silvia Radbauer, Franziska Reiner, Alois Hinterleitner: Archaeological prospection and excavations in Carnuntum – methodological basics

12:45

Jessica Preiß, Jürgen Obmann, Christof Flügel, Andreas Schafitzl: To see or not to see? Asking the right (research) questions for viewshed analysis on basis of the Upper German and Rhaetian Limes

13:00

Gillian Taylor, Tanja Romankiewicz, Caroline Orr: New geoarchaeological approaches to studying turf fortification walls

13:15
DISCUSSION

14:00
► LUNCH

15:30
SESSION 5

Periphery under pressure... redefining the late phase of the Roman limes in its arid borderlands.

Session introduction:
Tomasz Waliszewski,
Anna-Katharina Rieger

15:45

Alan Rushworth: Managing pastoralist migration in the Numidian frontier zone during the 2nd-5th centuries CE

16:00

Jan Baxter: Byzantine fortifications in Africa Zeugitana in the context of the Moorish Wars

16:15

Victor Ghica: The Western Desert Section of the Limes Aegyptiacus: A Swiss Cheese Defensive Model

16:30

Anna-Katharina Rieger: Routes, water, borders – a comparison of the infrastructure of the Roman and Byzantine borderlines in Syria and Aegyptus/Cyrenaica

16:45

Tomasz Waliszewski: Periphery under pressure – models of rural economies in southern Jordan in the 6th-8th centuries AD

17:00
► COFFEE BREAK

17:30

Brahim M'Barek, Pierre Simeon, Jamal Omar, Guillaume Charloux: Preliminary results of the first excavation campaign of an unknown antique fort at Maghair Shuyab (Al-Bad, Saudi Arabia)

17:45
DISCUSSION

9.09 MONDAY ROOM 42

10:00

SESSION 25

Frontiers before frontiers: the non-linear age of “Fuzzy Borders”, access control and military hotspots.
Session introduction:
Christoph Rummel,
Gabriele Rasbach,
Sandra Schroer-Span

10:15

Alexander Gramsch,
Kerstin P. Hofmann:
 Borderscaping. Concepts and Practices of Border Makings

10:30

Domagoj Tončinić,
Domagoj Bužanić,
Iva Kaić, Mirna Cvetko,
Mirjana Sanader:
 Grenzen vor Grenzen: Fallstudie der östlichen Adria

10:45

Patrick Hayes: Was there a Roman frontier in Sardinia?

11:00

Thomas Becker: Rome controls the landscape – observations on the security mechanisms in the southern Rhine foreland of Mainz

11:15

Lennart S. Niehues:
 The early imperial army in the Middle Rhine Valley

– a “frontier” from RIGOMAGVS to CONFLVENTES

11:30

DISCUSSION

11:45

► COFFEE BREAK

12:15

Harry van Enckevort:
 The command post on the Kops Plateau in Nijmegen. New insights

12:30

Zsolt Visy: Roman outposts outside of Dacia and Pannonia

12:45

Felix Marcu: The territory North of the Danube at the end of the 1st century A.D. and early 2nd century A.D.

13:00

Sandra Schröer-Spang:
 Fuzzy on the inside. An approach on the function and course of internal borders using the example of the border between Raetia and Germania Superior

13:15

David Breeze, Rien Polak:
 The creation of the map of Roman frontiers for the FRE project

13:30

DISCUSSION

14:00

► LUNCH

15:30

SESSION 21

One object, how many stories? The materiality of Roman Religion in the Roman Empire.
Session introduction:
Ljubica Perinić,
Anna Mech

15:45

Ivan Radman-Livaja:
 The dreams of an officer

16:00

Tomasz Dziurdzik:
 Two objects, one shared story: Roman soldiers' religion in the National Museum in Warsaw

16:15

Ana Kovačić, Maruša Urek, Luka Rozman:
 The beginning of Light

16:30

Ran Ortner:
 Conrad Schick's discovery and report of an Eagle marble statue from the Jerusalem Temple Mount

16:45

DISCUSSION

17:00

► COFFEE BREAK

17:30

Ljubica Perinić:
 The power of many – organized apparent chaos

17:45

Anna Mech: The materiality of female religious dedications in Dalmatia

18:00

Simon Sulk: Hercules in Moeno quiescit – Hercules rests in the river Main. A special bracelet from Hanau, Germany

18:15

Melissa Barden Dowling:
 Reexamining the burial goods of the Ivory Bangle Lady of York: Religious and cultural diversity on the northern frontier at the end of the Roman Empire

18:30

Nino Silagadze: Mithras of Trapezus – Syncretic Images at Pontic Limes

18:45

DISCUSSION

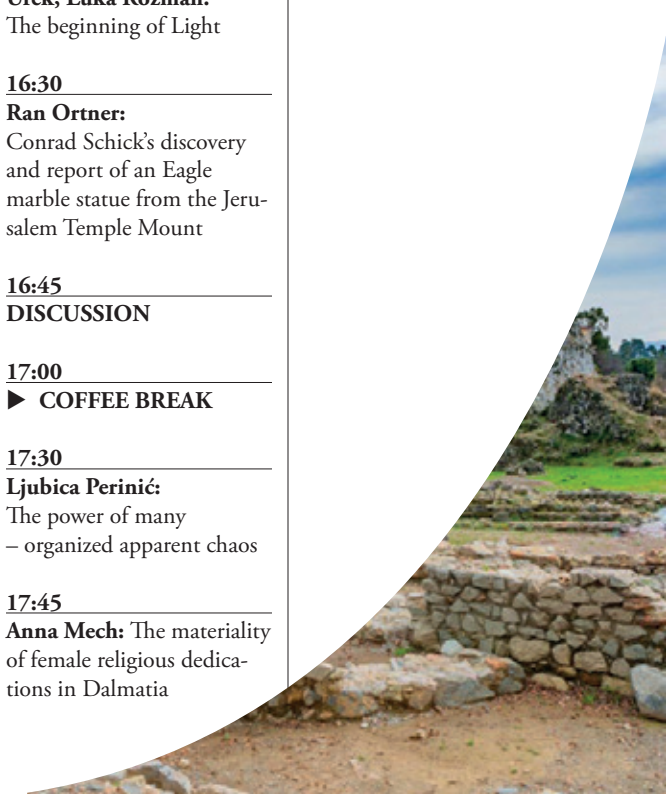

9.09 MONDAY ROOM 44

10:00

SESSION 19

Late Antique defensive construction programmes, theorisation, design, financing, implementation and combat testing... Late Antiquity as an apotheosis of poliorcetics. Session introduction: *Brahim M'Barek, Dan Aparaschivei*

10:15

Brahim M'Barek: The Siege of Amida (502-503) as a source of inspiration for innovations in Anastasio-Justinian military architecture. Telling a story behind the walls

10:30

Dan Aparaschivei: The last breaths of urban life in the border province of Scythia. The case of the city of Ibida

10:45

Tamara Ruske: Late Roman Fortifications in villae rusticae – the Example of the villa rustica HA 158 of Kerpen-Manheim (North Rhine-Westphalia, Germany)

11:00

Ștefan Honcu: Double click Filling a gap. Minor fortifications in the province of Scythia Minor

11:15

Salih Soslu: The siege of cremna (Turkey): Rome's war art, strategy and engineering

11:30

DISCUSSION

11:45

► **COFFEE BREAK**

12:15

Kalin Chakarov: Periodization of the fortress construction in the administrative territory of the Roman, late Roman and early Byzantine city of Nicopolis ad Istrum

12:30

Stefan Pop-Lazić: Characteristics of Felix Romuliana – Gamzigrad fortifications

12:45

DISCUSSION

14:00

► **LUNCH**

15:30

SESSION 11

If it is buried it is safe? The global impact of Climate change on the buried archaeology of the limes.

Session introduction:

Andrew Birley, Gillian Taylor

15:45

Rebecca Jones, Jon Day, Scott Heron: Towards a systematic approach to the assessment of climate risk across the FRE World Heritage cluster to support the strategic management of threats

16:00

Anna Tomkowska, Magdalena Skarzyńska: Conservator's Labyrinth: challenges in the conservation of call paintings at the Villa of Theseus in Nea Paphos, Cyprus, considering technique of execution and external factors amidst the challenges of climate change

16:15

Elizabeth M. Greene, Gillian Taylor: Impact of climate change on archaeological leather

16:30

Andrew Birley, Gillian Taylor: Managing the Roman landscape at the fort of Magna under the challenges of the climate emergency

16:45

DISCUSSION

17:00

► **COFFEE BREAK**



9.09 MONDAY ROOM 21

10:00

SESSION 8

Ripae – Roman River Frontiers and their Control.

Session introduction:
Gerald Grabherr,
Stefan Traxler

10:15

Martin Lemke,
George Nuțu: River, Land and Sea. News from the Scythian Limes

10:30

Miroslava Daňová,
Klaudia Daňová,
Ján Rajtár: The Roman military fort in Iža (UNESCO monument) and its connection with Brigetio. Latest results of the Danube River exploration and their comparison with known information

10:45

Gerald Grabherr: Strategic aspects of the organisation of the limes zone on the Danube in Noricum

11:00

Julia Klammer, Stefan Traxler: The watch on the Norican Danube Limes

11:15

Nemanja Mrđić, Saša Redžić, Mladen Jovičić: Treasuries of the Viminacium legionary fortress

11:30

DISCUSSION

11:45

► COFFEE BREAK

12:15

Melinda Szabó, Dávid Bartus: Known, but new. Recent discoveries in the legionary fortress of Brigetio

12:30

Martin Mosser: Vindobona as a prisoner of war camp and center of slave trade

12:45

Fabian Auer: New Insights on Late Antique Legionary Barracks in Lauriacum/Enns

13:00

Christoph Lindner: Fabrica or Warehouse Managment? New Insights into old Excavations at the Legionary Fortress Bonn

13:15

Simon Bence, Tino Leleković: Two times two forts. The special topography of two pairs of contemporary

13:30

Ljubomir Jevtović: Ripae legionis VII Claudia – the 7th Claudian legion and its construction activities in the late antiquity

13:45

DISCUSSION

14:00

► LUNCH

15:30

Fan Wang: An inquiry into milites naucarii – research on Later Roman Riverine Crews of military transport on Lower Danube at the turn of 5th century CE

15:45

Adam Łajtar: The primipilarii inscriptions from the legionary fortress at Novae and the Late Roman pastus militum

16:00

DISCUSSION

17:00

► COFFEE BREAK

17:30

SESSION 9

Roman limes of Mauretania Tingitana. Moroccan part of the World Heritage.
Session introduction:

Aomar Akerraz,
Maciej Czapski

17:45

Michael den Hartog: From the North to the South: Dynamic relations between Mauritania Tingitana and ethnic units from the northern provinces

18:00

Maciej Czapski: Roman watchtowers in Mauretania Tingitana

18:15

Fadoua Benjaâfar: The military establishments in Mauretania Tingitana between the year 40 and 429 AD

18:30

DISCUSSION

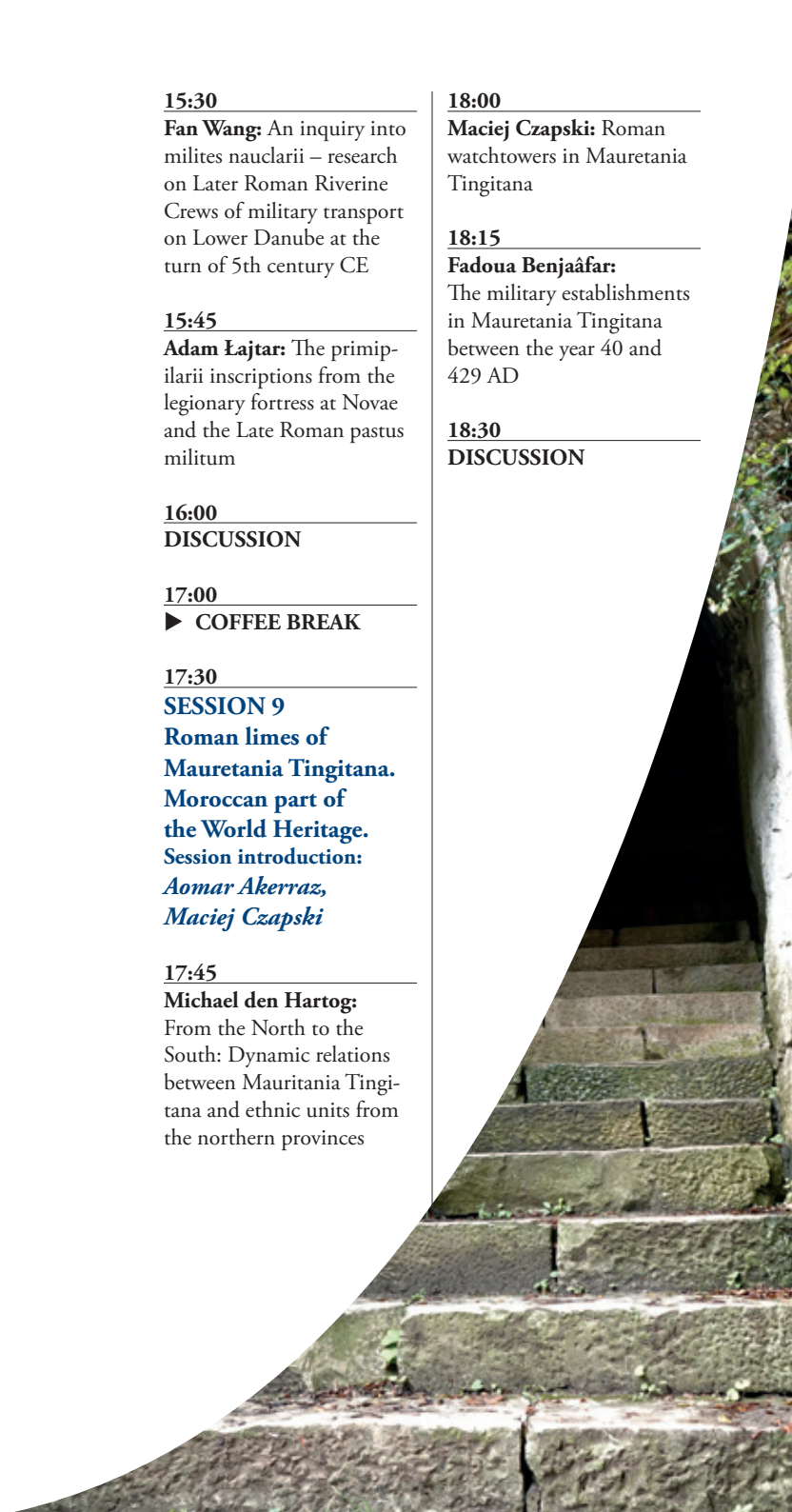

9.09 MONDAY ROOM 55

10:00
SESSION 26

Arms, armour and other military equipment from the limes and beyond.

Session introduction:

Balázs Komoróczy, Martijn A. Wijnhoven

10:15

Hannes Flück, Raphael Berger, Claudia Gerling, Thomas Reitmaier, Peter-Andrew Schwarz: Gimme shelter – on the tactics of the fundatores and the ballistics of their glands

10:30

Ferdinand Heimerl, Lars Blöck, Magdalena Machura, Stephanie E. Metz: Missing link, secured at the last second – Remarkable weapon finds from a Late Iron Age burial near Meurich (Germany)

10:45

Guy Stiebel: “Between the anvil and the hammer”: Militaria as part of the archaeology of resistance in Roman Judaea

11:00

Matěj Kmošek, Martijn A. Wijnhoven: Mastering metalwork: Exploring a newly discovered Roman armour decoration technique

11:15

Paul Güldenstern: Lorica segmentata finds from the auxiliary fort of Aalen

11:30

DISCUSSION

11:45

► **COFFEE BREAK**

12:15

Jost Mergen: The evolution of Niederbieber helmets: protecting Roman infantry

12:30

Martijn A. Wijnhoven, Balázs Komoróczy: New insights into Roman military leg protection and development: The iron greaves from Mušov

12:45

Alka Starac: Few but eloquent: Elements of armour and military belts from Iстриa

13:00

Eva Thysell, Barbara Kainrath: Beaded rim fittings and other regional peculiarities of the military belt from the region of Lauriacum/Enns (AUT).

13:15

Martin Wieland: “Ye shall know them by their belts”: ‘aprons’ depicted on soldiers’ tombstones of the late 1st century AD

13:30

Bartosz Kontny: Roman soldiers far beyond the limes

– unexpected finds from Central Poland

13:45

DISCUSSION

14:00

► **LUNCH**

15:30
SESSION 33

The horses of Roman cavalry units / Die Pferde römischer Kavallerieeinheiten.

Session introduction:

Andreas Thiel, Thomas Becker

15:45

Goldie Nagy: To live and die side by side – the conceptualization and utilization of equines by the Roman Imperial army on the basis of depictions / Seite an Seite leben und sterben – Konzeptualisierung und Verwendung von Equiden durch das römische Heer der Kaiserzeit anhand von Darstellungen

16:00

Susan Rands: Cavalry Rations on the Northern Frontier in Britannia in the First Century AD

16:15

Andreas Thiel: Where have all the horses gone? The whereabouts of the mounts of Roman cavalry units

16:30

Boris Burandt, Monika Schernig-Mráz: The horses of Gelduba. New data on 193 horse skeletons from a Roman conflict landscape of the year 69 AD

16:45

Eva Steigberger, Alfred Galik: “Er hat ein Haus, ein Hündchen und ein Pferd...” / “He’s got a house, a dog and a horse...” (after Astrid Lingren’s Pippi Longstocking)

17:00

DISCUSSION

17:15

► **COFFEE BREAK**

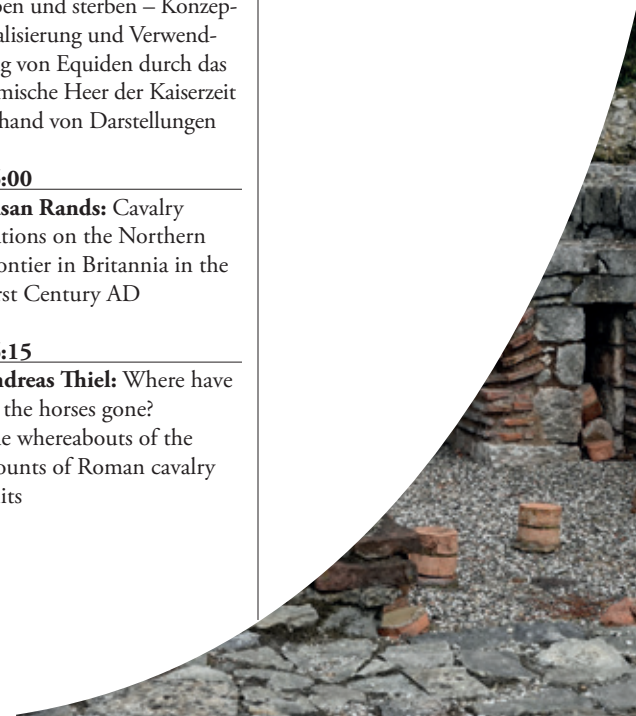

9.09 MONDAY GREAT HALL

10:00

SESSION 1

Over the sea and far away. Roman garrisons and Roman influences in the Southern Caucasus.

Session introduction:

Radosław Karasiewicz-Szczypiorski, Emzar Kakhidze, Piotr Jaworski

10:15

Radosław Karasiewicz-Szczypiorski: Flavius Arrianus in Apsaros. Written sources and archaeology

10:30

Tornike Mamiseishvili, Lasha Aslanishvili: New stamps and building activity of Cohors Sagittariorum from Gonio-Apsaros

10:45

Marcin Matera: Ceramic production in Gonio-Apsaros

11:00

Małgorzata Daszkiewicz, Radosław Karasiewicz-Szczypiorski: Ceramic building materials at the Roman for Apsaros (Gonio, Georgia). Local or regional products or imports?

11:15

Leszek Łęczyński, Radosław Karasiewicz-Szczypiorski, Radosław Mieszkowski, Aleksandra Zgrudno, Shota Mamuladze † : Geoarchaeological research of the Black Sea coastal zone in the area of the Roman Apsaros Fort in Gonio (Georgia)

11:30

DISCUSSION

11:45

► COFFEE BREAK

12:15

Radosław Mieszkowski, Stanisław Mieszkowski, Krzysztof Misiewicz: Non-invasive research of the surroundings of the fort in Apsaros in order to locate the remains of defence systems and reconstruct the archaeological landscape

12:30

Paulina Komar, Maciej Sierakowski: Peeking into legionary's pots – military diet in the Roman fort of Apsaros

12:45

Natalia A. Lockley: What does the pot say? Local kitchenware from Roman fort Apsaros (Georgia)

13:00

Marcin Wagner: Transparent, translucent, and opaque – 1st-2nd century AD glass from Apsaros, Georgia

13:15

Piotr Jaworski, Irina Varshalomidze: 200 years of coin circulation in Apsaros, a Roman fort in Colchis

13:30

Eliso Baghaturia-Kner: Command, experience and origin: warriors from NW Colchis (300-400 AD)

13:45

Kakhaber Kamadadze, Shota Mamuladze †, Tatuli Motskobili: The main results of archaeological excavations carried out at different times at the southwestern part of the Apsaros fort

14:00

DISCUSSION

14:15

► LUNCH

15:30

SESSION 36
Roman and early Byzantine sites located in Georgia.
Session introduction:
Lasha Aslanishvili, Kakhaber Kamadadze, Shota Mamuladze † (in memoriam)

15:45

Tamar Shalikadze, Emzar Kakhidze: Roman Imperial and early Byzantine period glassware discovered in southwestern Georgia

16:00

Tariel Ebralidze, Emzar Kakhidze: Roman Imperial period terra sigillata, louth-eria and lamps discovered in southwestern Georgia

16:15

Irine Varshalomidze, Nino Dzneladze, Lasha Aslanishvili: Roman Coins from South-western Georgia

16:30

Miranda Turmanidze: Roman Period Jewelry from south-western Georgia

16:45

DISCUSSION

17:00

► COFFEE BREAK

17:15

Merab Khalvashi, Nino Inaishvili: The Roman and Early Byzantine Amphorae from Eastern Black Sea Littorals

17:30

Nodar Bakhtadze, Vazha Mamiashvili: Archaeological Survey of the Early Christian Basilicas of the Kingdom of Iberia

17:45

David Gagoshidze: The Palace of Dedoplist Gora: The residence of an Iberian Nobleman of the 1st century (new discoveries)

18:00

DISCUSSION





10.09 **TUESDAY**
TRIPS DURING CONGRESS

As part of the congress, we have organized two excursions, scheduled for Tuesday.

1st OPTION

10:00-11:00

Khariton Akhvlediani Museum & Art Museum

11:30-12:30

Fort of Batumi & Museum of Religion

13:30-15:30

Pichvnari (Coffee & Wine Break)

2nd OPTION

08:00-15:00

Vani Archaeological Museum

JOINT ACTIVITIES

16:30-18:30

Fort of Petra (Cocktail)

For the excursions, regardless of which option you have chosen, the **pick-up point** will be at the University.

11.09 WEDNESDAY ROOM 20

10:00

SESSION 4

Buffer zones in archaeology.

Session introduction:
Krzysztof Narloch, Oliva Menozzi

10:15

Krzysztof Narloch: Buffer zones as a potential tool for politics and war

10:30

Mirko Rašić, Tomasz

Dziurdzik: Internal buffer zone, policing, logistics? A Domitianic reconstruction of a fort in Dalmatia and its role in a pacified province

10:45

Friederike T. Kranig: Cross Border Identity: Demarcation through music as a universal language?

11:00

Paola Zanollo,

Andrea Meleri: Cultural and Religious Interrelations Along the Roman Limes in Algeria: Archaeological and Epigraphic Evidences

11:15

Zhang Jingqiu: Study on the problems and role of World Heritage Buffer Zones in the perspective of urban development – case study on small Wild Goose Pagoda site

11:30

DISCUSSION

11:45

► COFFEE BREAK

12:15

SESSION 14

Geophysical prospecting in Roman border regions – sharing technical knowhow and encouraging sustainable knowledge transfer.

Session introduction:
Nikola Babucic, Martina Seifert

12:30

William Hanson, Richard Jones, Nick Hannon:

Keeping in line: a review of 25 years of geophysical survey along the Antonine Wall

12:45

Esperanza Martín

Hernández, Antxoka

Martínez-Velasco: Prospecting the roman army in burgos: different techniques, sites and results

13:00

Klaus Löcker, Mario

Wallner, Stefan Traxler,

Ralf Totschnig, Tanja

Trausmuth-Wallner,

Hannes Schie, Jakob

Gallistl, Barbara Kainrath,

Gerald Grabherr, Eduard

Pollhammer, Alois

Hinterleitner: A new riddle at the Danube – a large-scale motorized geophysical survey of the Roman vicus of Stein, Austria

13:15

Cristina-Georgeta

Alexandrescu, Christian

Gugl, Mario Wallner,

Klaus Löcker, Franziska

Reiner, Hannes Schiel,

Ralf Totschnig, Alois

Hinterleitner: Troesmis

2023 – Recent geophysical prospecting and geoarchaeological research

13:30

Paweł Lech, Martina

Seifert, Nikola Babuci,

Łukasz Miszk: Teaching

geophysics at Roman

Frontier – from basics to

summer school

13:45

Jarosław Bodzek, Kamil

Kopij, Łukasz Miszk,

Nikola Babuci, Paweł

Ćwiakała, Edyta Puniach:

Beyond the Walls: Geophysical Survey of the Vicus of the Castellum at Da'janiya, Jordan

14:00

DISCUSSION

14:15

► LUNCH



**11.09 WEDNESDAY
ROOM 20**

15:30

SESSION 20

Roman-Barbarian Interaction. Materialising diplomacy, East and West. Comparing Roman diplomacy across different parts of the limes.

Session introduction:

*Szilvia Bíró,
Fraser Hunter,
Thomas Grane,
Thomas Schierl*

15:45

**Ekaterine Kobakhidze,
Natia Phiphia:** Basilissa Ulpia – New Circumstances in Roman-Iberian Diplomatic Relations

16:00

**Arkadiusz Dymowski,
Kyrylo Myzgin:** Once again on the influx of Late Roman gold coins north of the Carpathian Basin

16:15

Lana Chologauri: Roman and Sasanian silverware from Colchis and Iberia: evidence for diplomatic interaction with Rome and Persia

16:30

Fraser Hunter: The role of silver in Roman diplomacy and frontier politics – a comparative approach

16:45

Aleksander Bursche, Kiryl Myzgin: Gold Medallions in Barbaricum and Late Roman Diplomacy

17:00

DISCUSSION

17:15

► **COFFEE BREAK**

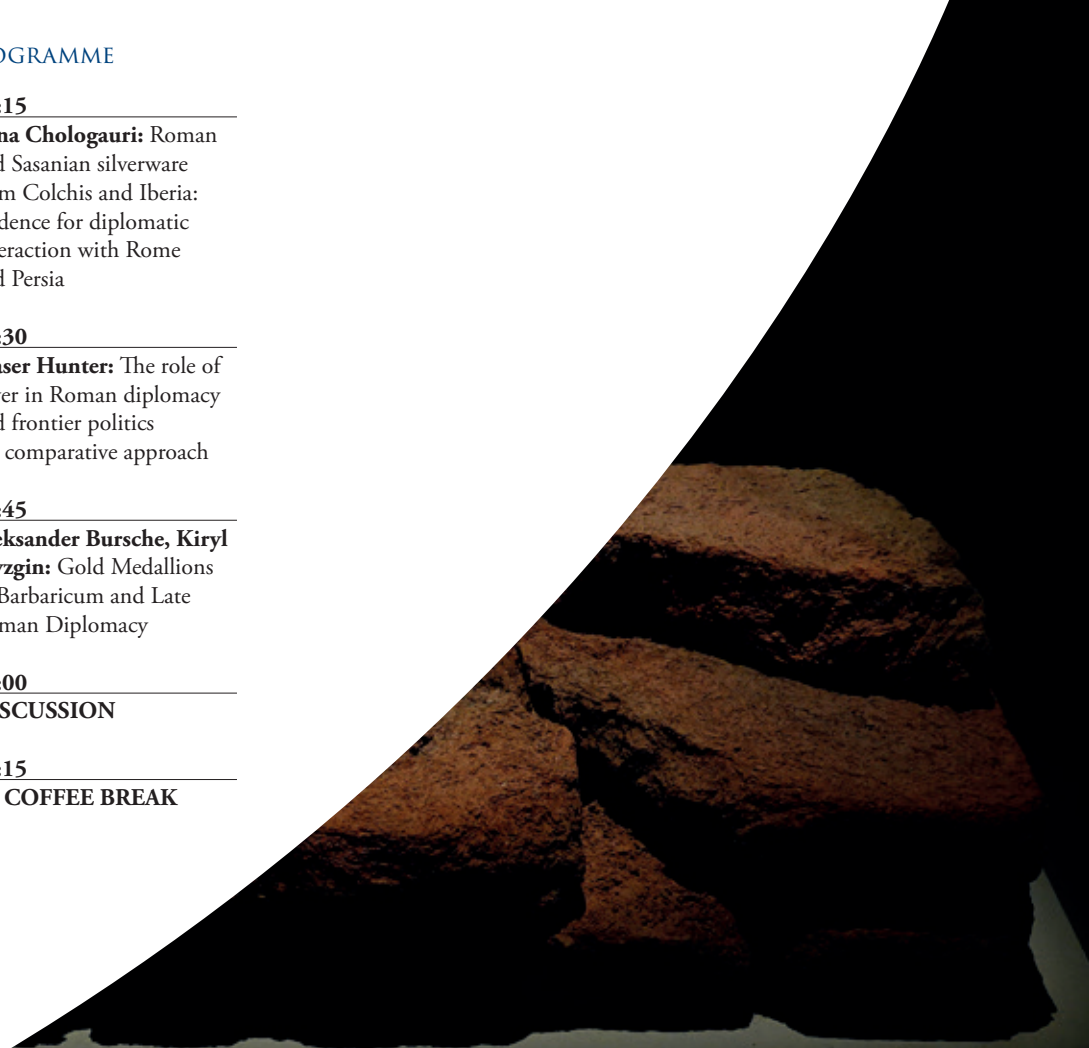

11.09 WEDNESDAY ROOM 42

10:00

SESSION 31

It's all been done before. Why re-evaluating 19th and 20th century excavations is worth it.
Session introduction:
Frances McIntosh,
Orsolya Lang

10:15

Orsolya Láng: Castrum and/or municipium? The history of identifying the Aquincum civil town and the ideas of the pioneer archaeologists

10:30

Milica Tapavički-Ilić: Roman camps – the sunken roman fort on the Danube: an overview of oil-lamps

10:45

Frances McIntosh, Catherine Teitz: Found, lost, and found again: results from the Corbridge Finds Project

11:00

Katja Roesler: Disiecta membra. On collecting scattered and forgotten knowledge about Roman stone architecture in Germany.

11:15

René Ployer: Today more valuable than ever – the beginning of the research of the Danube Limes

11:30

DISCUSSION

11:45

► COFFEE BREAK

12:15

Tanja Romankiewicz, Andrew Lawrence, Gillian Taylor: Res Re-Gestae Trimontio: Things Re-Done at Trimontium

12:30

Michaela Kronberger, Joachim Thaler: Brief insights into the past. Research on the street system of ancient Vindobona in the context of construction measures in Vienna's inner city

12:45

Domagoj Bužanić, Domagoj Tončinić, Vinka Matijević, Mirjana Sanader: Reviewing water supply of the Roman legionary fortress Tilverium

13:00

DISCUSSION

14:00

► LUNCH

15:30

SESSION 24

Rituals on the borders.
Session introduction:
Jason Lundock,
Kaja Stemberger,
Alessandra Esposito,
David Walsh

15:45

André Nordin: Ritualised object-practices at the Roman Iron Age Ölandic cemetery of Sörby-Störlinge, Sweden

16:00

David Walsh: Ritual, Rubbish, or Both? Modern Depositions at the Carrawburgh Mithraeum

16:15

Frederic Auth: Ritual depositions in the central sanctuary of NIDA/ Frankfurt-Heddernheim (Germany)

16:30

Markus Scholz, Carsten Wenzel: The end of rituals: on the abandonment of sanctuaries in the Limes area of Upper Germany and Raetia

16:45

DISCUSSION

17:00

► COFFEE BREAK

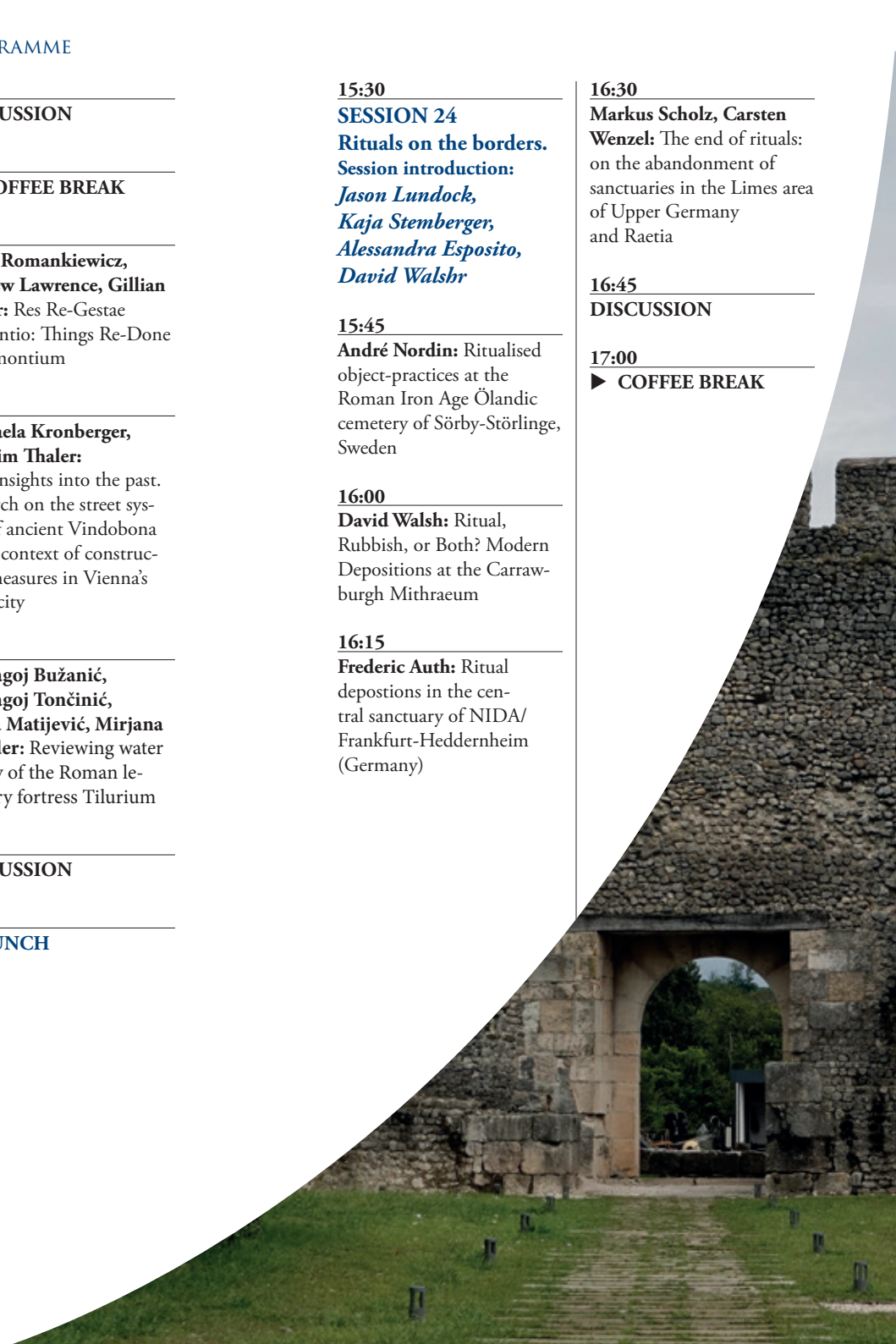

11.09 WEDNESDAY ROOM 43

10:00

SESSION 30

Reconstructing Handicrafts on the Limes.

Session introduction:

*Kaja Stemberger,
Jason Lundock*

10:15

**Viktoria Čistáková,
Zuzana Zlámalová Cílová:**

Study of technology of roman period objects with enamelled and millefiori decoration

10:30

**Milica Marjanovic,
Ilija Dankovic:** Loom weights and weaving craft in Viminacium

10:45

Rüdiger Schwarz: Craft as a method to gain insights into Roman woodworking – practical examples

11:00

Amy Baker: Using craft activity to understand social practice on the Antonine Wall

11:15

Tomas Janek: The military manufacture and distribution of tiles in Vindobona

11:30

Tatiana Ivleva: An exploration into glass bangle and glass working crafts in Roman frontier zone of Britain

11:45

DISCUSSION

12:00

► COFFEE BREAK

12:15

SESSION 15

The Roman Army Beyond the Provinces.

Session introduction:

Michael A. Speidel

12:30

Samuele Rocca: Inside and Beyond the “limes”: the attitude of the Jewish communities to Palmyra

12:45

Adam Łukasiewicz: Cavalry in a frontierland? Remarks on a papyrus fragment from a Georgian collection

13:00

Adrian Ardeț: Army-Religious beliefs and trade between the Orient and the Danube Provinces

13:15

Dario Nappo: An army for ‘India’? The Roman fleet in the Red Sea

13:30

Fatih İnan: Roman traces east of the Caspian Sea: Kara-Kamar?

13:45

DISCUSSION

14:00

► LUNCH

15:30

Sebastien Mazurek:

The Roman presence on the island of Farasan revisited in the light of the epigraphical sources

15:45

Jean Coert: Royal veterans welfare. Client rulers as patrons and benefactors of veteran Roman soldiers in the early principate

16:00

Tomasz Derda, Adam Łajtar, Tomasz Płóciennik:

The southernmost outpost of the Roman army at Primis (Qasr Ibrim) under Augustus: New evidence from Greek and Latin papyri

16:15

Oskar Kubrak: Presence of the Roman army on the “Stone Hill” and its surroundings

16:30

Leonardo Gregoratti: The control of the steppe east of Palmyra. A Palmyrene limes?

16:45

DISCUSSION

17:00

► COFFEE BREAK

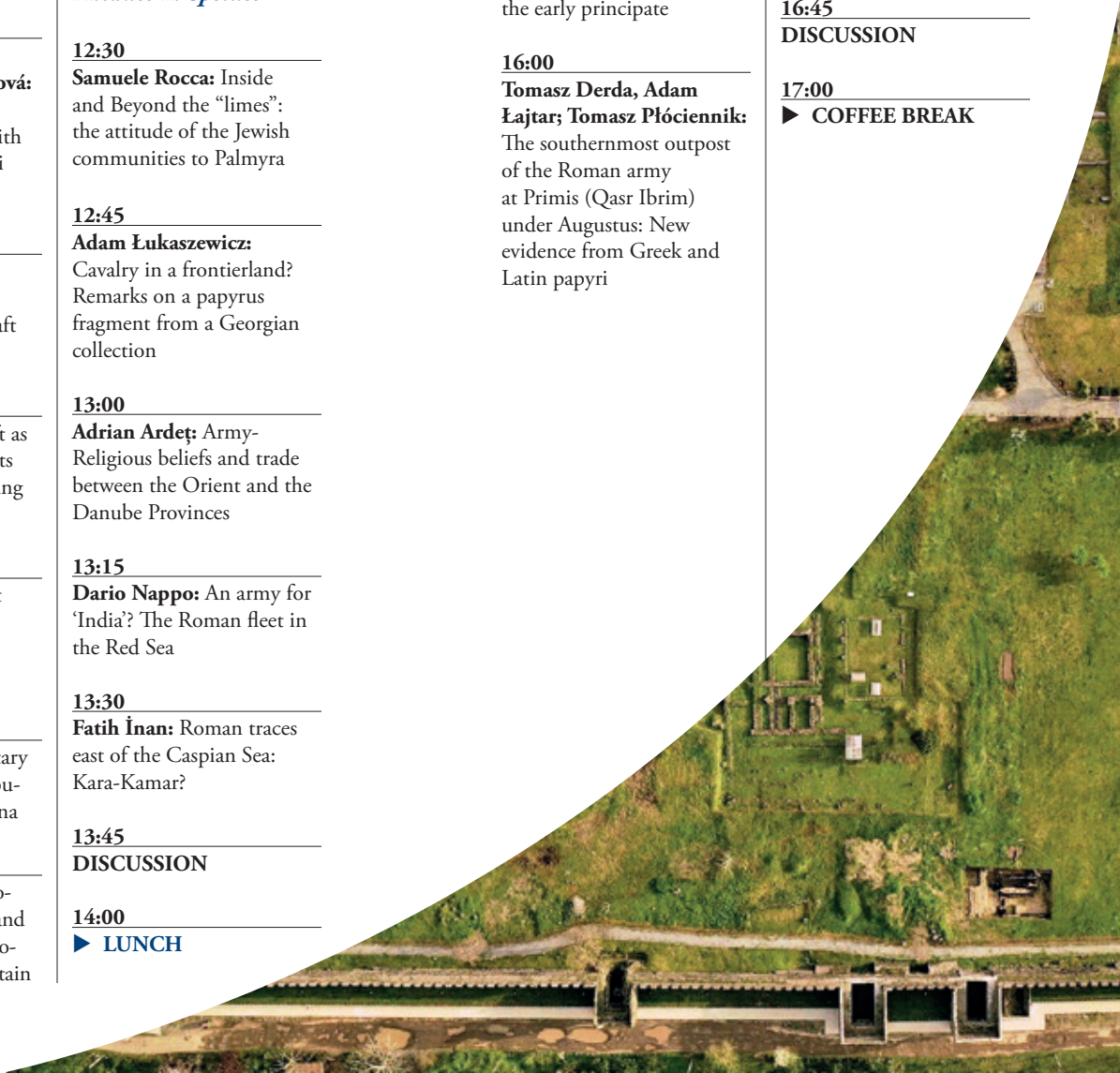

11.09 WEDNESDAY GREAT HALL

10:00
SESSION 39
General session.
Session introduction:
*Matthew J. Adams,
Martin Lemke*

10:15

Pete Wilson: Mind the gap: questioning our understanding of coastal defence in Northern Britannia in the Later Roman Period

10:30
Janka Istenič, Vesna

Tratnik: The Battle of Frigidus: archaeological evidence found at last?

10:45
**Sofie Vanhoutte, Vince
Van Thienen, Jasper**

Deconynck: The late Roman coastal fort at Oudenburg (Belgium): new research developments

11:00
Martin Dietrich:

Roman Metal Lamps from Baden-Wuerttemberg

11:15

Craig A. Harvey: Keeping up with the Nabataeans?

The Decorative Wall Paintings and Mosaic Floors of the Hauarra Praetorium

11:30
DISCUSSION

11:45
► COFFEE BREAK

12:15

Orsolya Szilágyi: Memories of Dacia. Private archaeological collections and the rise of antiquarianism in 19th century Transylvania

12:30
Erich Claßen, Jennifer

Schamper: If you build it, they will come – new visitor centres at the Lower German Limes

12:45
**Matthew J. Adams, Yotam
Tepper, Mark Letteney:**

Six Seasons of Excavation at the Castra of Legio VI Ferrata, Israel

13:00
Markus Gschwind:

In Front or Behind the Ditches? Mounds as a Standard Element of the Fortifications of Roman Forts

13:15
Mark A. Hassler:

Two Roman Military Conquests at Khirbet el-Maqatir, Israel: Archaeological Findings from the First and Second Jewish Revolts against Rome

13:30
Alexandra Ratzlaff,
Erin Brantmayer:

Birsama: unraveling the economic, military, and administrative dynamics of the Roman Negev

13:45
DISCUSSION

14:00
► LUNCH

15:30
Matthew J. Previto:

Was There a Roman Settler Colonialism? The Evidence and What it Means for Decolonizing Roman Archaeology

15:45

Samuel Agbamu: When is a boundary not a boundary? The strange place of the Mediterranean between Roman antiquity and today

16:00
Szymon Jellonek:

Coin finds from the Retentura of the Legio I Italica camp in Novae

16:15
Maria-Magdalena

Mancini: An archaeozoological survey at the former bus station – an insight into the nutrition, economy and trade of the Romans living at the Limes in Neuss

16:30
Artak Dabaghyan:

On a Missing Ring in the circumponic travel of the rriitual of rising on a shield from the Early Medieval Caucasian Albania

16:45
Maruša Urek, Ana
Kovačič, Luka Rozman:

New and old Castra

17:00
► COFFEE BREAK

17:30

Tom Hazenberg: Bridging the North Sea. Connectivity in the North Sea basin in Roman and modern times

17:45
Szilamér Pánczél, Katalin

Sidó: Individual and group identity and their imprint on the material culture. Case study on the eastern limes of Roman Dacia

18:00
Veronika Golianová,
Jakub Žaludko,
Margareta Musilova:

Heritage Quest AR

18:15
Carl Pause, Till
Lodemann, Andreas

Wegert: Searching for the Late Antique Castellum in Novaesium/Neuss

18:30
DISCUSSION

11.09 WEDNESDAY ROOM 55

10:00

SESSION 6

Rethinking Borderlands: Examining the Outer Hinterlands of the Roman Empire.

Session introduction:

Manuel Fernández-Götz, Dominik Maschek

10:15

Dominik Maschek:

A Farewell to the Frontier: Trans-European Connectivities in the Roman Empire

10:30

José Manuel Costa-García, Manuel Gago-Mariño, Francisco Alonso-Toucido, Jorge Sanjurjo Sánchez:

Sailing along to Brigantium: The Roman expansion in northern Galicia between the late republican and early imperial times

10:45

Romain Andenmatten, Tristan Allegro, Gwenaël Bertocco, Anad's Deville, Julia Genechesi, Paul-Emile Mottiez, Déborah Rosselet, Nicole Reynaud Savioz: When Seduni women tell the story of the long-lasting Romanization of the Upper Rhône Valley between 70 BC and 70 AD

11:00

Rebecca Jones, Matt

Symonds: Seeking shadows? Resistance and Roman

militarisation in southwest Scotland

11:15

Christopher Rummel:

Not quite beyond the Northern Frontier: landscape archaeology between Birrens and Burnswark

11:30

DISCUSSION

11:45

► **COFFEE BREAK**

12:15

Manuel Fernández-Götz, Dave Cowley, Derek Hamilton, Ian Hardwick, Sophie McDonald:

Transformations in the northern British borderlands: Perspectives from the “Beyond Walls” project

12:30

John Reid, Manuel Fernández-Götz: Unrest after conquest: The attack on Ambleside Roman Fort

12:45

Russell Ó Riagáin:

The Role of Foederati and secondary states in Ireland, Britain and Fennoscandia during the era of Late Roman Hegemony, c. AD100–700

13:00

Zdenek Beneš, Viktoria Čistakova: Roman imports and Germanic elites – a case study of settlement Vrbová Lhota (Central Bohemia)

13:15

Marek Vlach, Balázs

Komoróczy: Borderland Dynamics: exploring interactions between Germanic and Roman Worlds in the middle Danube Region through comprehensive archaeological data

13:30

Ioana A. Oltean, Sorin

Bulzan: Looking West: re-assessing the archaeological evidence for the Roman limes and its hinterland outside Dacia

13:45

DISCUSSION

14:00

► **LUNCH**

15:30

Susanne Hakenbeck:

Violence on the edge of empire: case studies from beyond the Danube

15:45

Alexandru Flutur, Liana

Flutur: Fossatum Sarmatiae – a Late Roman economic border

16:00

Ian Colvin: The Romans' South Caucasian wars AD 522-572 – why the Romans provoked war with Sasanian Persia over Lazika and the Caspian Gates

16:15

Geoffrey Greatrex:

The Roman Frontier in Mesopotamia in the Sixth

Century and Justinian's Eastern Strategy

16:30

Christopher Lillington-

Martin: Procopius' fort building “on the very borders of Persia” (Minduos / Μίνδουος)

16:45

Annegret Plontke-Lüning, Frank Schleicher: Between Byzantine and Sasanian Empires? The ‘Lakada limes’ in Northern Colchis in Late Antiquity (5th-8th c.)

17:00

► **COFFEE BREAK**

17:30

Emilia Smagur, Mariusz Gwiazda: Gods and Coins: Roman objects agency and the Blemmyes

17:45

Mariusz Drzewiecki: Forts of North Omdurman

18:00

DISCUSSION

11.09 WEDNESDAY ROOM 44

10:00

SESSION 27

Hoarding on the Roman frontiers and...beyond.

The interpretation of coin assemblies with and without archaeological contexts: military, civilian, and funerary.

Session introduction:

Cristian Gazdac

10:15

Cristian Gazdac: 'Military' vs 'civilian' hoards, antoninianus vs denarius. Are there specific patterns of hoarding based on to the burial environment?

10:30

Kyrylo Myzgin, Arkadiusz Dymowski: Purses, votive deposits or...? Mini-hoards of Roman coins in Barbaricum

10:45

Tedo Dundua: Coins on the Pontic Limes and beyond: Patterns of Hoarding in Lazica/Western Georgia

11:00

Lajos Juhász: Detecting hoards in the Hungarian Barbaricum. Hoarding in light of metal detecting activity

11:15

Renata Ciolek:

Münzumlauflauf in Niedermösien (Moesia Inferior) im Lichte der Münzfunde aus dem Legionslager in Novae (Bulgaria)

11:30

DISCUSSION

11:45

► COFFEE BREAK

12:15

Anna Zapolska: "Moving wealth" – the presence of Roman gold in Barbaricum based on the Trąbki hoard in N Poland

12:30

David Wigg-Wolf: Hoarding beyond the frontier: the case of Germania Magna

12:45

DISCUSSION

14:00

► LUNCH

15:30

SESSION 32

Via Nova: New Perspectives on the Roman Roads in the Roman Frontier Studies.

Session introduction:

Adam Pažout

15:45

Tünde Kaszab-Olschewski:

Eine unbekannte Staatsstraße (via publica) im Hinterland von Köln (An unknown state road (via publica) in the hinterland of Cologne)

16:00

Lina Diers: Road or River? Investigating Transport Systems for Ceramic Goods between the Stara Planina and the Danube in Moesia Inferior/Thracia in the 2nd/3rd Century AD

16:15

Adam Pažout, Tom Brughmans: Wheels or no wheels: suitability of roads for vehicular traffic in Judaea and Arabia

16:30

Ofer Stein: A new proposal for geo-archaeological dating method for Milestones – a case study from the Scythopolis Region

16:45

Jacopo Turchetto: Tibaalinyin landscape project. a roman road and its settlement at the edge of the limes in the eastern aurès (Algeria)

17:00

DISCUSSION

17:15

► COFFEE BREAK



11.09 **WEDNESDAY**
FIRST FLOOR
MAIN HALL

18:30
POSTER SESSION

Andreas Pangerl,
Robert Lehmann:

The first comprehensive metallurgical study of Roman military diplomata – constant alloy quality was maintained by the Roman military administration over 200 years from ca. 60-260 AD

Agnieszka Tomas,
Jakub Kaniszewski,
Wiesław Więckowski:

Reviving Roman army religiosity: digital reconstructions of statues and sacred space in the principia of the legionary fortress at Novae

Dragoș Măndescu,
Ion Dumitrescu:

Roman military paraphernalia recently found in Barbaricum, near the south-eastern limes of Dacia

Bogdan Ciupercă,
Cătălin Discă, Tudor Hila:

The presence of Rome in Muntenia. Archaeological Evidence of the interaction between Romans and Barbarians on the Teleajen Valley

Cătălin Discă, Tudor Hila,
Bogdan Ciupercă:

On the Border between Political Agreements and Military

Actions. Roman Policies in Muntenia Reflected in Archaeological Discoveries

Vesna Tratnik: Justinian's authority in Slovenia – militaria and lead seals from Zidani gaber

Eugen-Marius Paraschi-Grigore, Adela Băltăc, Ioana Paraschiv-Grigore:

The stamps of the XI Claudia legion discovered in the settlement at Ostrov (Constanta County)

Hana Ivezić,
Jana Kopačkova:

Old finds from the area of Bassianae – an overview

Matthew Clark: Vision, Movement and Access on the British Frontier: a GIS study of Roman surveillance and counter mobility

Ozren Domiter:

Hermes-Thot in Lower Pannonia

Angelina Raičković Savić,
Ana Mitić:

The end of the pottery production in Viminacium? Ceramic material from castrum

Saša Redžić:

Belt-sets with ring-shaped buckles from Viminacium (Serbia)

Mihaela Iacob,
Dorel Paraschiv:

Ibida – a fortified system in the province of Scythia

Karolina Trusz:

Underwater surveys of the Limes Maritimus Scythicus Project: an overview

Silvia Bekavac,
Željko Miletić:

End of Second Dacian War and post of praefectus vehiculorum

Željko Miletić,
Silvia Bekavac:

Lucius Artorius Castus and the British troops

Oskar Kubrak,
Lasha Aslanishvili:

Stone Projectiles from Roman Fort Apsaros, Georgia

Esperanza Martín Hernández, Antxoka Martínez-Velasco, Kepa García-Martínez:

Cantabrian Wars in Palencia (Castilla y León, Spain). New contributions to the knowledge of the Cantabrian wars

Renata Ciolek:

Provincial coin finds in Novae (Bulgaria)

Bridget Buxton, Caesar Bita, Alexandra Ratzlaff:

Was there a Roman Frontier in the Indian Ocean?

Birgit Nennstiel:

Speed, Efficiency, and Grandeur: Earthfast-Post Construction for Roman Military Camps

Piotr Dyczek:

How the wooden barracks of the 1st cohort of the legio VIII Augusta at Novae were built

Lucia Clara Formato:

The early Roman cemetery of Potzneusiedl (Burgenland, AT) – inhumations of autochthonous inhabitants in the hinterland of the later Danube border

Dajana Ehlers:

Looters or heroes: how are treasure hunters portrayed in video games?

Ivana Ožanić Roguljić, Angelina Raičković Savić:

Roman snake vessels: cult, religion or just tableware?

Katarina Lukić:

Salus Reipublicae: Last decades of the regular coin supply to the limes in the Pannonia Secunda

Sofie Vanhoutte:

Jozef Mertens, pioneer in late Roman military archaeology in Belgium

Piotr Zakrzewski, Anna Mech, Tomasz Dziurdzik:

Tadeusz Sarnowski – archaeologist, epigraphist, historian and more (film)

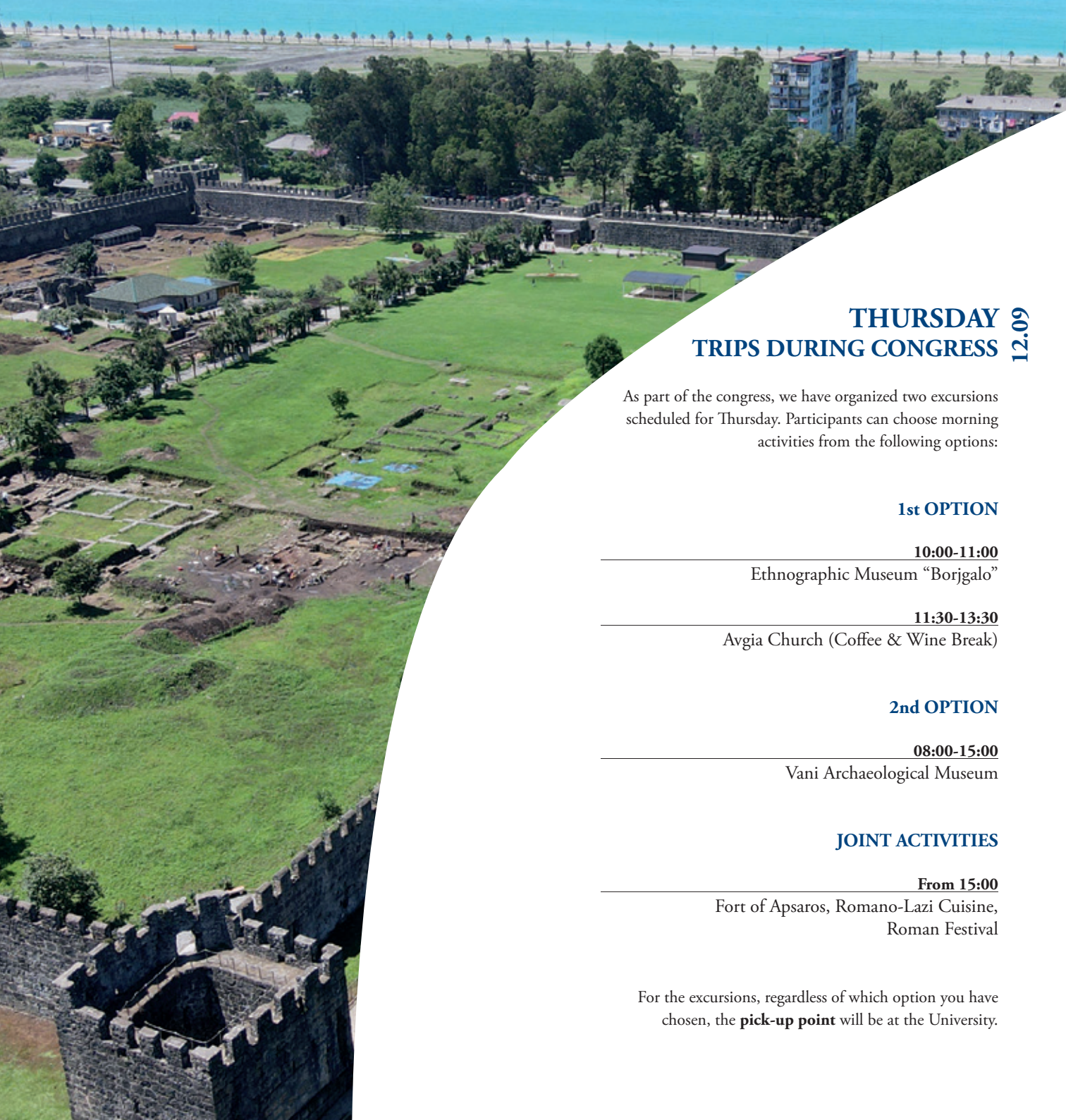

THURSDAY TRIPS DURING CONGRESS

12.09

As part of the congress, we have organized two excursions scheduled for Thursday. Participants can choose morning activities from the following options:

1st OPTION

10:00-11:00

Ethnographic Museum “Borjgalo”

11:30-13:30

Avgia Church (Coffee & Wine Break)

2nd OPTION

08:00-15:00

Vani Archaeological Museum

JOINT ACTIVITIES

From 15:00

Fort of Apsaros, Romano-Lazi Cuisine,
Roman Festival

For the excursions, regardless of which option you have chosen, the **pick-up point** will be at the University.

13.09 FRIDAY ROOM 42

10:00

SESSION 18

Death and burial along the limes.

Session introduction:
Erik Timmerman, Jana Wertz

10:15

Kaja Stemberger Flegar:

The normal, the abnormal, and the unnoticed

10:30

Snezana Golubović, Jelena Andelković-Grasar, Milica Marjanović:

Viminacium at the Crossroads of the Roman Empire – research of the necropolis

10:45

Ivana Kosanović: Graves with instrumenta scriptoria from Viminacium (Moesia Superior)

11:00

Andrés Cid-Zurita:

Collective singularity: a theoretical approach to the issuing of sepulchral inscriptions of infants and children in the Western Roman Empire, I-III centuries AD

11:15

Erik Timmerman:

The Roman burial fields in Nijmegen East

11:30

DISCUSSION

11:45

► **COFFEE BREAK**

12:15

Mariola Hepa:

Roman Cemetery of Biricianis

12:30

Tony Wilmott: The cemetery of the Hadrian's Wall fort of Birdoswald'

12:45

Wiesław Więckowski, Matthew Addams, Yotam Tepper: The Roman Legionary cemetery at Legio – preliminary results

13:00

Jana Wertz: The late antique cemetery of the roman legionary camp in Bonn

13:15

Rebecca Nashan: Building robust chronologies for late antique finds. A multilayered approach to dating late antique burials along the Rhine frontier

13:30

DISCUSSION

14:00

► **LUNCH**

15:30

SESSION 12

Putting 3D imaging to work on the Roman frontiers: Next steps in visualizing archaeology and heritage.

Session introduction:
Elizabeth Greene, Barbara Birley

15:45

Laetitia Stott, Peter Holms, Barbara Birley, Neil Melton: The Call of Rome: Putting 3D imaging to work on the Roman frontiers

16:00

Elizabeth Wolfram Thill: Of Sculptures and Scanners: Integrating Capital and Frontier Commemorative Traditions Through 3D Modeling

16:15

Rhys Williams, Anneke Hackenbroich, Barbara Birley, Gillian Taylor: 3D Imaging at Vindolanda

16:30

Jernej Umek, Rok Bremec, Blaž Kumer, Kaja Stemberger Flegar: Capture them if you can: Utilising modern technologies in the context of Roman archaeology

16:45

DISCUSSION

17:00

► **COFFEE BREAK**

17:30

Alex Meyer: 3D Imaging of the Vindolanda Stylus Tablets: Current and Future Technology

17:45

Amanda Hardman: The Use of 3D Imaging on the Shoe Stamps of Vindolanda

18:00

Kamil Kopij, Tomasz Dziurdzik, Adam Pilch, Szymon Popławski, Monika Drab: Exploring acoustic and visual aspects of Roman camp rituals: a case study of Principia in Novae, Bulgaria

18:15

DISCUSSION



13.09 **FRIDAY**
ROOM 20

15:30

**SESSION 2 [hybrid]
Between Danube and
Bosporus. Roman mili-
tary presence in Scythia
and Taurica.**

Session introduction:

*Oleg Saveliev,
Marcin Matera,
Radosław Karasiewicz-
Szczypiorski*

15:45

**Vyacheslav Gerasimov,
Oleksandr Smyrnov:**
Underwater archaeological
research in Olbia and its
chora

16:00

Roman Kozlenko:
The Roman Military
Presence in Olbia Pontica

16:15

Iryna Sheiko: Lamps
from Olbia Pontica as
the possible component
of the Roman military
presence

16:30

**Lucrețiu Bîrliba,
Ana Honcu:** Roman Army
North of the Black Sea. The
Case of Beneficarii

16:45

DISCUSSION

17:00

► **COFFEE BREAK**

17:30

**Oleh Saveliev, Kateryna
Saveliev:** About the Roman
military presence in Tyras
in the 2nd – middle
3rd centuries AD

17:45

Oksana Ruchynska:
Board Games in Roman
Chersonesos Taurica

18:00

Oleh Vus, Serhii Sorochan:
Roman military presence in
the Crimea in the epoch of
Diocletian and Constantine
the Great (end of III – first
half of the IV centuries AD)

18:15

DISCUSSION

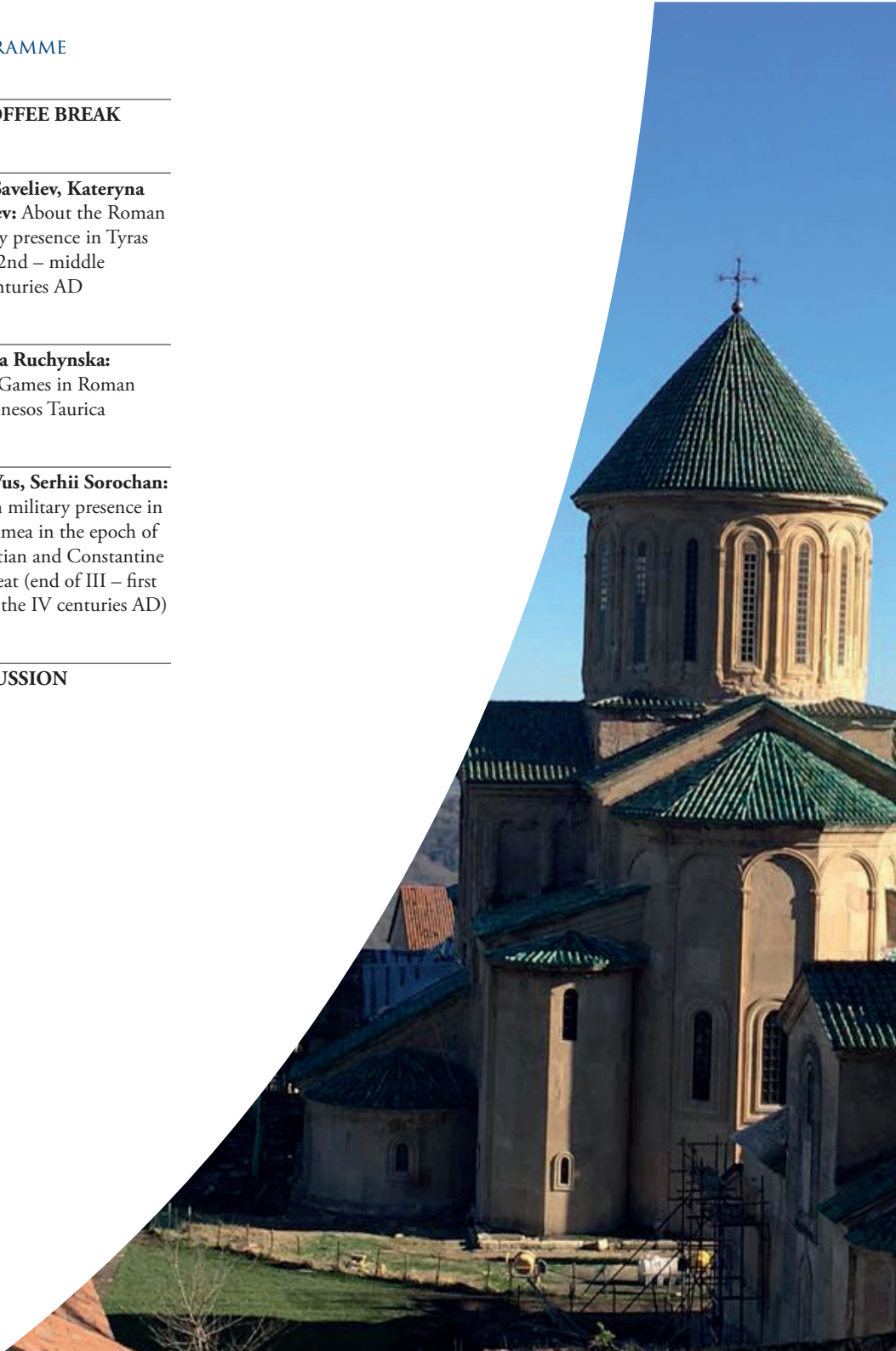

13.09 FRIDAY ROOM 44

10:00

SESSION 38

Roman provinces and frontiers in the studies of young researchers.

Session introduction:

Adrianna Gizińska,

Natalia Lockley

Oskar Kubrak

10:15

Daniel Nykjær Andersen:

Sentinels of the Republic:

Early Roman castra as

a model for later frontiers

10:30

Birgit Nennstiel:

Fast, efficient and impressive: The construction of the principia and praetorium as large-scale timber buildings in the Augustan camp at Marktbreit

10:45

Rita Olsz: Excavated, but (not) forgotten. The cemeteries of Brigetio in Pannonia province

11:00

Petar Kojadinović: Soldier's Everyday Life on the Limes of the Middle Danube

11:15

Dominika Schmidtova,

Ştefania Dogărel,

George Cupcea, Ricardo

Fernandes: Exploring the different lifeways of the Roman Dacia population by a multidisciplinary approach

11:30

DISCUSSION

11:45

► **COFFEE BREAK**

12:15

Adrianna Gizińska: Loyalty carved in Stone: Pro salute imperatoris Dedications from Moesia Inferior and the Severan dynasty

12:30

Bartłomiej Kukla, Marcin

Wagner: Glass bowl decorated with ribbons from Apsaros, Georgia

12:45

Karolina Warecka,

Andrzej Szotek:

Two ballista bullets from Marina el Alamein. What can we say about the presence of Roman army troops?

13:00

Krisztián Tóth: Barbarians in the roman army? A new research in North Hungary at the frontier of Pannonia province

13:15

Adam Telązka: Ancient iron smelting on both sides of the limes. Research of a young scientist

13:30

DISCUSSION

14:00

► **LUNCH**

15:30

Eleonora Pawlikowska:

Antler combs from Moesia Superior adorned with zoomorphological motifs – tiny masterpieces from the Migration Period

15:45

Ivona Jukičić, Domagoj Tončinić, Siniša Radović:

An insight into animal exploitation at the Roman legionary fortress Tilverium

16:00

DISCUSSION

17:00

► **COFFEE BREAK**

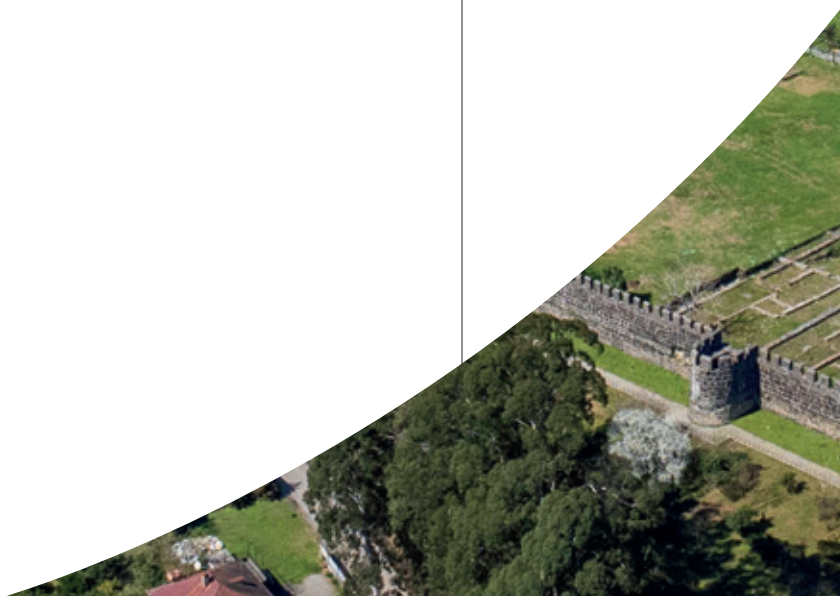

13.09 FRIDAY ROOM 55

10:00

SESSION 34

The military and long-distance trade along the eastern Roman frontier.

Session introduction:

Craig A. Harvey, Emanuele E. Intagliata, Rubina Raja

10:15

Andria Rogava: Local goods for Roman army: an archaeometric study of „Colchian” brown-clay amphoras from Apsaros (Georgia)

10:30

Craig Harvey, Emanuele Intagliata, Rubina Raja:

Past geopolitics in the borderlands: New research on military and trade presence at Khirbet al-Khalde – Wadi al-Yutm, Aqaba Governorate

10:45

Mette Lang: Via Nova Traiana – facilitating movement

11:00

DISCUSSION

11:45

► **COFFEE BREAK**

12:15

SESSION 3

New Research on the eastern Roman frontier – Southern Pontos, Cappadocia, and the Upper Euphrates Valley.

Session introduction:

Julia M. Koch, Şahin Yıldırım

12:30

Julia M. Koch: Roman expansionist efforts, resettlement and Pontic responses – negotiating collective cultural identity and lost homelands in northern Anatolian funerary art.

12:45

S. Yücel Şenyurt:

Excavations at Kurul Fortress and archaeological evidence for the historicity of the Roman invasions of Southern Pontos

13:00

Carole Raddato: Hadrian's peregrinations around the Black Sea

13:15

Zeki Mete Aksan, Hazar Kaba, Gülseren Kan Şahin: A Necropolis in the Hinterland of Sinope

13:30

Özge Deniz Toköz, Tonguç Akış: Preserving the Anatolian Frontier of the Roman Empire: Conservation Challenges and Remarks for a Holistic Conservation Approach

13:45

DISCUSSION

14:00

► **LUNCH**

15:30

Kai Juntunen: The extent and mechanisms of Roman power in the upper Euphrates region during the Principate

15:45

İlhami Tekin Cinemre:

After 387 AD: Psychological Boundaries between Roman Armenia and Persarmenia

16:00

Şahin Yıldırım, Bernard van Daele: Satala: New Excavations and Research on the Eastern Limes of the Roman Empire

16:15

Kerim Altuğ: From archive to field: New archaeological evidence from the Cappadocian Frontier in Late Antique and Early Byzantine periods

16:30

Viktor Humennyi: Garrisons of the Upper Euphrates area and the Parthian campaigns of the 2nd century CE: the epigraphical perspective

16:45

DISCUSSION

17:00

► **COFFEE BREAK**

17:30

Edward Dandrow, Julia M. Koch: Remote Sensing and Roman Forts in the Upper Khabur Tributary System: Exploring a Conflict Landscape beyond the Euphrates towards Persia

17:45

Ramazan Bozkurttan:

A New Military Post in the Territory of Nisibis?: Ruins of Hirberesk and Its Connection with Tur Abdin

18:00

Sylvain Janniard: Circulation and stationing of the Comitatus units: the operation of frontier military installations in the Late Antique West (4th-5th centuries AD)

18:15

DISCUSSION

13.09 FRIDAY ROOM 21

10:00

SESSION 16

What has a Roman fort ever done for us? Social and spatial identities on the frontier. Part One: Unwashed barbarians and murdering soldiers. Frontier's society between self-perception and propaganda.
Session introduction:
Martina Meyr, Christof Flügel, Catherine Teitz

10:15

Nick Hodgson: Infant burials in late-Roman barracks at South Shields and their significance

10:30

Eduard Nemeth: Ethnic and social diversity at the frontiers of the Danubian Roman Provinces. Study case of Pannonia(s)

10:45

Ceren Pilevneli-Çubuk: Saviour or just another enemy?: Roman provincials and Roman Army in times of Tumult

11:00

Monica Gui: Living in the shadow of the forts on the Dacian frontier

11:15

Al McCluskey: Everyday Strategy: Understanding space, place, objects and identities on the Roman Frontier

11:30

DISCUSSION

11:45

COFFEE BREAK

12:15

Catherine Teitz: At the edge of empire and expectations: forts as urban spaces

12:30

Jane Harrison: Frontier towns and forts: urban-military interactions and identities in Carlisle and Corbridge, UK

12:45

Andy Lawrence: Modelling Movement – approaching concepts of interaction, access and control in military contexts using Space Syntax Analysis

13:00

Steve Bödecker: In modum municipii? The extramural settlement of Vetera castra in the context of Roman urban development

13:15

Ştefania Dogărel: The differences between and within: the use of space inside Roman military bases

13:30

George Cupcea, Felix Marcu, Ştefania Dogărel, Ioniță Petiș: Who lived in the praetorium of Bologa, Dacia?

13:45

DISCUSSION

14:00

► LUNCH

15:30

Andreas Schafnitzl: Always follow your nose! A new fortlet at Mögglingen

15:45

Ian Haynes, Tony Wilmott: Recent work on the extramural settlements of forts in the Hadrian's Wall frontier zone with particular reference to excavations at Birdoswald, Cumbria (2021-2024)

16:00

Adela Băltăc, Eugen Marius: In the shadow of a fort: the Roman settlement at Ostrov (Constanta County)

16:15

DISCUSSION

16:30

SESSION 13

Virtual Frontiers.

Session introduction:

Nigel Mills, Veronika Fischer, Snežana Golubović, Erik Dobat

16:45

Martina Meyr: From project to process or how

to start a revolution in your museum with low budget

17:00

Stefan Stančić: The use of 3D Photogrammetry as a method in analysis and presentation of archaeological artefacts on the example of the archaeological site Viminacium

17:15

► COFFEE BREAK

17:30

Jelena Andelković Grašar, Selma Rizvić, Snežana Golubović: Virtual reality and reality of Danube Limes sites Viminacium and Lederata within the "Roman Heritage in the Balkans"

17:45

Ljubomir Jevtović, Ivan Bogdanović, Zorica Velkovska: IMMERSIUM – The lessons learned from using immersive storytelling in the presentation of cultural heritage

18:00

Veronica Fisher: Ideas for the sustainability of digital applications - examples of digital interpretation approaches at the Roman frontiers in Bavaria

18:15

DISCUSSION

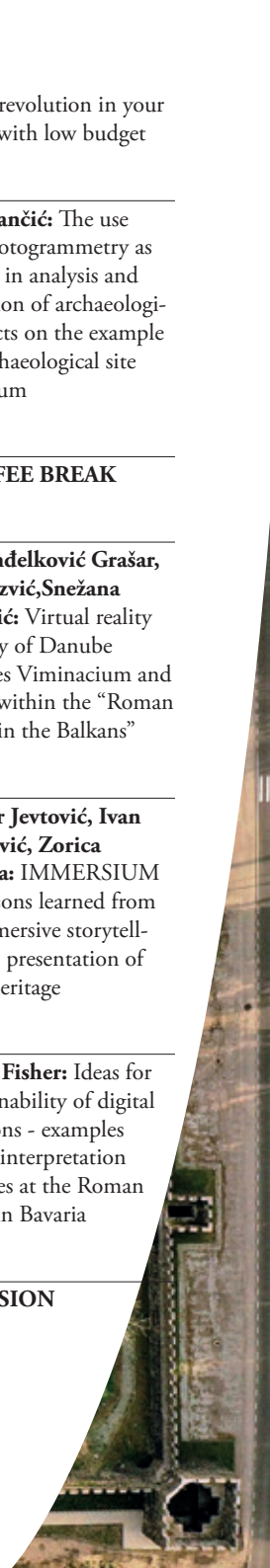

13.09 FRIDAY ROOM 43

10:00

SESSION 23

Comparing imperial frontiers – Rome, Persia and China.

Session introduction:

*David Brough,
Rob Collins*

10:15

Rob Collins: Imperial Frontiers and the Value of Cross-cultural Comparison

10:30

Eberhard W. Sauer, Jebrael Nokandeh, Lana Chologauri, Hamid Omrani Rekavandi, Davit Naskidashvili: Sasanian frontier studies in the twenty-first century

10:45

Anthony Comfort: Sasanian Persia's frontier with Rome in northeastern Mesopotamiat

11:00

Xue Cheng: The Great Wall of China and Chinese Imperial Civilization

11:15

DISCUSSION

11:45

► **COFFEE BREAK**

12:15

Wang Yao, Xiaoyue Shang, Yan Li: The Spatial Distribution of Fortifications in Relation to Rivers on the Great Wall of the Han Dynasty, China

12:30

Fei Cheng, Dong Xiao, Qian Gao: Landscape Dynamics and Adaptation of the Great Wall of China Amidst Climate Change

12:45

Liang Tao: The Role of the Great Wall System on the Silk Roads

13:00

Karim Alizadeh: Population Policies in the Borderlands: a comparative approach to the borderlands of the Roman, The Sasanian, and the Han Empires

13:15

Zehao Li: The energetics analysis of masonry of the Qin-Han wall in Inner Mongolia (China)

13:30

DISCUSSION

14:00

► **LUNCH**

15:30

SESSION 29

More than dating: re-evaluating coin finds in military contexts.

Session introduction:

Rahel Otte, Max Resch

15:45

Max Resch: Beyond the Chronology? The Coins from Kalkriese

16:00

Liesbeth Claes, Vincente Fischer de Miranda Rodrigues, Rowan Rip: Coins of the auxiliary camps in the Netherlands (AD 138-330)

16:15

Giel Verbeelen: The Rhine Limes and its influence on the Civitas Tungrorum. The Roman City of Tongeren as a case study

16:30

Matthias K. Kalisch:

Visualization and classification of Roman coin finds and their archaeological context: The case of Bad Wimpfen

16:45

Rahel Otte: Old Coins, New Questions – Challenges in Analysing Roman Coin Finds

17:00

DISCUSSION





**14.09 SATURDAY
CLOSING CEREMONY**

The plenary session of the Congress of Roman Frontier Studies and the closing ceremony of the XXVI Limes Congress will take place at the **Batumi Shota Rustaveli University**, starting at **12:00**.

CLOSING CEREMONY SCHEDULE

12:00

Plenary session

Rebecca Jones & Andreas Thiel

Announcement of the awards

Proposal for the 27th Limes Congress

Discussion

14:00

Closing Ceremony

17:00

Gala dinner at Megrul Lazuri restaurant

Address: Makhinjauri, Tbilisi Highway 16

EXECUTIVE COMMITTEE

Dr. Rebecca Jones
National Museums Scotland

Dr. Andreas Thiel
Landesamt für Denkmalpflege

ORGANIZING PROGRAMME COMMITTEE

Dr. Kahaber Kamadadze
Cultural Heritage Protection
Agency of Ajara

Megi Tetemadze
Ajara Museums

Dr. Karolina Trusz

Marta Rizhvadze
Ajara Museums

Dr. Sulkhan Mamuladze
Cultural Heritage Protection
Agency of Ajara

Sopo Komakhidze
Ajara Museums

Keti Dumbadze
Cultural Heritage Protection
Agency of Ajara

Merab Uzunadze
Ajara Museums

Tornike Mamiseishvili
Cultural Heritage Protection
Agency of Ajara

Natalia A. Lockley
Polish Centre of Mediterranean
Archaeology, University of Warsaw

Guranda Dolidze
Ajara Museums

Maciej Czapski
Polish Centre of Mediterranean
Archaeology, University of Warsaw

COMITTEE OF RECOMMENDATION

Zaur Akhvediani
Director of the Cultural Heritage
Protection Agency of Ajara;
Deputy Minister of the Ministry
of Education, Culture and Sport of
Autonomous Republic of Ajara

Dr. Tamar Siradze
Vice Rector of the Batumi Shota
Rustaveli State University

Dr. Sopio Sanikidze
Deputy Director of the Cultural
Heritage Protection Agency of Ajara

Dr. Anzor Beridze
Vice Rector of the Batumi Shota
Rustaveli State University

Gocha Kakhidze
Head of the Administration of
Cultural Heritage Protection
Agency of Ajara

Dr. Teona Beridze
Dean of Faculty of Humanities of
the Batumi Shota Rustaveli State
University

Dr. Teona Zoidze
Director of Ajara Museums

Dr. Jemal Karalidze
Head of Department of History,
Archaeology and Ethnology of
the Batumi Shota Rustaveli State
University

Inga Gogiberidze
Deputy Director of Ajara Museums

Merab Diasamidze
Head of Administration of
the Batumi Shota Rustaveli
State University

Prof. Merab Khalvashi
Rector of the Batumi Shota Rustave-
li State University

Prof. Alojzy Nowak
Rector of University of Warsaw

Prof. Artur Obluski
Polish Centre of Mediterranean
Archaeology, University of Warsaw

Prof. Grzegorz Majcherek
Polish Centre of Mediterranean
Archaeology, University of Warsaw

Prof. Bartosz Kontny
Faculty of Archaeology,
University of Warsaw

Prof. Piotr Dyczek
Antiquity of Southeastern
Europe Research Centre,
University of Warsaw

Prof. Aleksander Bursche
Faculty of Archaeology,
University of Warsaw

Prof. Michael A. Speidel
University of Zurich

SCIENTIFIC PROGRAMME COMMITTEE

Dr. Emzar Kakhidze
Batumi Archaeological Museum,
Ajara Museums;
Professor of the Batumi Shota
Rustaveli State University

Dr. Martin Lemke
Faculty of Archaeology,
University of Warsaw

**Prof. Radosław Karasiewicz-
Szczypiorski**
Polish Centre of Mediterranean
Archaeology, University of Warsaw

Dr. Piotr Zakrzewski
Polish Centre of Mediterranean
Archaeology, University of Warsaw

Dr. Lasha Aslanishvili
Head of Archaeological and
Architectural Complexes,
Archaeology and Educational
Department of the Cultural
Heritage Protection Agency of Ajara

† **Prof. Amiran Kakhidze**
Professor Emeritus of the Batumi
Shota Rustaveli State University;
Advisor of the Director of the
Batumi Archaeological Museum

Dr. Piotr Jaworski
Faculty of Archaeology,
University of Warsaw

† **Prof. Shota Mamuladze,**
Professor Emeritus of the Batumi
Shota Rustaveli State University;
Head of the Research Institute of
the Cultural Heritage Protection
Agency of Ajara

CODE OF CONDUCT

The International Congress of Roman Frontier Studies (Limes Congress) is committed to provide a harassment-free and discrimination-free congress experience for everyone, regardless of gender, gender identity and expression, age, sexual orientation, disability, physical appearance, body size, race, ethnicity, religion or belief. Harassment of any kind to speakers, congress staff, volunteers and attendees will not be tolerated within the Limes Congress. Harassment includes offensive verbal comments related to gender, gender identity and expression, age, sexual orientation, disability, physical appearance, body size, race, ethnicity, religion, technology choices, sexual images in public spaces, deliberate intimidation, stalking, following, harassing photography or recording, sustained disruption of talks or other events, inappropriate physical contact, and unwelcome sexual attention.

No attendee should under any circumstance engage in harassment of other attendees either in person or online. Participants asked to stop any harassing behavior are expected to comply immediately. If a participant engages in harassing behavior, the congress organisers may take any action they deem appropriate, including warning the offender or expulsion from the current and/or future congress with no refund. If you are being harassed, notice that someone else is being harassed, or have any other concerns, please contact a member of congress staff immediately.

Congress staff can be identified as they will be wearing branded clothing and/or badges.

Congress staff will be happy to help participants contact hotel/venue security or local law enforcement, provide escorts, or otherwise assist those experiencing harassment to feel safe for the duration of the congress.

We expect participants to follow these rules at conference and workshop venues and conference-related social events.

We value your attendance.

BACK COVER

Fragment of a floor mosaic from the praetorium, discovered by the Georgian-Polish expedition in the Roman fort of Apsaros, dating back to the first half of the 2nd century.



Photos and texts:
Cultural Heritage Protection Agency of Ajara
Radosław Karasiewicz-Szczypiorski
Zaur Akhvlediani
Martin Lemke
Emzar Kakhidze
Lasha Aslanishvili
Piotr Zakrzewski
Keti Dumbadze
Karolina Trusz
Gocha Kakhidze
Bartomiej Kujda
Anna Bucholc
Maciej Czapski
Natalia Lockley
Oskar Kubrak

Graphic design: © Karolina Trusz